

Prisliste længder, garderoberør, profiler, tæppeskiner, klaverhængsler, m. m.

22.10.2012

Nr.	EAN Nr.	TUN	Tekst	Indh.	Enh.	PG	Pris	Bestil.
-----	---------	-----	-------	-------	------	----	------	---------

INVENTAR, GULVSTANDERE OG TÆPPESKINNEOPHÆNG

35.902			Sokkel, 200 mm	1	Stk.			
35.907			Profilstativ, H72, B44,5, D15	1	Stk.			
35.909			Profilstativ, H92, B44,5, D15	1	Stk.			
35.911			Profilstativ, 900 / 1100 mm	1	Stk.			
35.913			Profilstativ, 1100 mm	1	Stk.			
35.927			Profilstativ, H 70, B 58, D 14,5	1	Stk.			
35.928			Profilstativ, H 80, B 58, D 14,5	1	Stk.			
35.929			Profilstativ, H 90, B 58, D 14,5	1	Stk.			
35.930			Profilstativ, H100, B 58, D 14,5	1	Stk.			
35.931			Profilstativ, H110, B 58, D 14,5	1	Stk.			
35.940	5701733359407		Krogbom m.firkantet huller	1	Stk.			
35.941	5701733359414		Konsoller 210 mm	1	Sæt			
35.942	5701733359421		Konsoller 380 mm	1	Sæt			

GARDEROBERØR, FORMESSINGEDE JERNRØR



30.010	5701733300102	3770781	Rør, formessinget, 1/2", 1,0 m	1	Stk.	F		
30.015	5701733300157	3770799	Rør, formessinget, 1/2", 1,5 m	1	Stk.	I		
30.020	5701733300201	3770807	Rør, formessinget, 1/2", 2,0 m	1	Stk.	K		
30.050	5701733300508	3770815	Rør, formessinget, 1/2", 5,0 m	1	Stk.	Q		
30.110	5701733301109	3770823	Rør, formessinget, 3/4", 1,0 m	1	Stk.	G		
30.115	5701733301154	3770831	Rør, formessinget, 3/4", 1,5 m	1	Stk.	J		
30.120	5701733301208	3770849	Rør, formessinget, 3/4", 2,0 m	1	Stk.	L		
30.150	5701733301505	3770856	Rør, formessinget, 3/4", 5,0 m	1	Stk.	R		
30.210	5701733302106	3770864	Rør, formessinget, 1", 1,0 m	1	Stk.	H		
30.215	5701733302151	3770872	Rør, formessinget, 1", 1,5 m	1	Stk.	K		
30.220	5701733302205	3770880	Rør, formessinget, 1", 2,0 m	1	Stk.	M		
30.250	5701733302502	3770898	Rør, formessinget, 1", 5,0 m	1	Stk.	T		

GARDEROBERØR, FORNIKLEDE / FORCROMEDE JERNRØR



30.310	5701733303103	3795051	Rør, jern, forniklet, 1/2", 1,0 m	1	Stk.	F		
30.315	5701733303158	3770906	Rør, jern, forniklet, 1/2", 1,5 m	1	Stk.	I		
30.320	5701733303202	3770922	Rør, jern, forniklet, 1/2", 2,0 m	1	Stk.	K		
30.350	5701733303509	3770930	Rør, jern, forniklet, 1/2", 5,0 m	1	Stk.	Q		
30.410	5701733304100	3770948	Rør, jern, forniklet, 3/4", 1,0 m	1	Stk.	G		
30.415	5701733304155	3770955	Rør, jern, forniklet, 3/4", 1,5 m	1	Stk.	J		
30.420	5701733304209	3770963	Rør, jern, forniklet, 3/4", 2,0 m	1	Stk.	L		
30.450	5701733304506	3770971	Rør, jern, forniklet, 3/4", 5,0 m	1	Stk.	R		
30.510	5701733305107	3770989	Rør, jern, forniklet, 1", 1,0 m	1	Stk.	H		
30.515	5701733305152	3770997	Rør, jern, forniklet, 1", 1,5 m	1	Stk.	K		
30.520	5701733305206	3771003	Rør, jern, forniklet, 1", 2,0 m	1	Stk.	M		
30.550	5701733305503	3771011	Rør, jern, forniklet, 1", 5,0 m	1	Stk.	T		

Nr.	EAN Nr.	TUN	Tekst	Indh.	Enh.	PG	Pris	Bestil.
-----	---------	-----	-------	-------	------	----	------	---------

**GARDEROBERØR,
HVIDE, PVC BELAGTE JERNRØR**



31.210	5701733312105	4896882	Rør, jern, PVC hvid 1/2", 1,0 m	1	Stk.	D		
31.215	5701733312150	4896890	Rør, jern, PVC hvid 1/2", 1,5 m	1	Stk.	F		
31.220	5701733312204	4896908	Rør, jern, PVC hvid 1/2", 2,0 m	1	Stk.	G		
31.250	5701733312501	4896916	Rør, jern, PVC hvid 1/2", 5,0 m	1	Stk.	M		
31.310	5701733313102	3771102	Rør, jern, PVC hvid 3/4", 1,0 m	1	Stk.	D		
31.315	5701733313157	3771110	Rør, jern, PVC hvid 3/4", 1,5 m	1	Stk.	G		
31.320	5701733313201	3771128	Rør, jern, PVC hvid 3/4", 2,0 m	1	Stk.	H		
31.350	5701733313508	3771136	Rør, jern, PVC hvid 3/4", 5,0 m	1	Stk.	N		
31.410	5701733314109	3771144	Rør, jern, PVC hvid 1", 1,0 m	1	Stk.	F		
31.415	5701733314154	3771151	Rør, jern, PVC hvid 1", 1,5 m	1	Stk.	I		
31.420	5701733314208	3771169	Rør, jern, PVC hvid 1", 2,0 m	1	Stk.	K		
31.450	5701733314505	3771177	Rør, jern, PVC hvid 1", 5,0 m	1	Stk.	Q		

**GARDEROBESTANG,
TRÆ**



31.460	5701733314604	5689875	Garderobestang, træ, Ø 24, 1,0 m	1	Stk.	G		
31.465	5701733314659	5689876	Garderobestang, træ, Ø 24, 1,5 m	1	Stk.	J		

**KILEFLANGER,
TIL RØR 10 - 25 MM**



29.458	5701733294586	3602331	MINIPAK, kileflange, jern, gul	2	Pose	11		
29.460	5701733294609	3602349	MINIPAK, kileflange, nylon, hvid	2	Pose	8		
31.918	5701733319180	3771383	Kileflange, jern, gul, 3/8 - 1"	50	Æske			
31.920	5701733319203	3771391	Kileflange, nylon, hvid, 3/8 - 1"	50	Æske			

**ENDEKNAPPER,
PLAST, HVIDE**



29.479	5701733294791	3602471	MINIPAK, endeknap, hvid 3/4"	2	Pose	7		
29.480	5701733294807	3602489	MINIPAK, endeknap, hvid 1"	2	Pose	7		
31.879	5701733318794	3771300	Endeknap, hvid 3/4"	1	Stk.			
31.880	5701733318800	3771318	Endeknap, hvid 1"	1	Stk.			

**RØRHOLDERE,
NYLON, HVIDE**



29.484	5701733294845	3602497	MINIPAK, rørholder, hvid, 3/4"	2	Pose	14		
29.487	5701733294876	1675529	MINIPAK, rørholder, hvid, 1"	2	Pose	17		
31.984	5701733319845	4015517	Rørholder, nylon, hvid, 3/4"	1	Stk.			
31.987	5701733319876	3878584	Rørholder, nylon, hvid, 1"	1	Stk.			

**RØRHOLDERE,
NYLON, HVIDE**



29.490	5701733294906	1658806	MINIPAK, rørholder, hvid, 20 mm	2	Pose	14		
29.492	5701733294920	1658814	MINIPAK, rørholder, hvid, 25 mm	2	Pose	14		
31.993	5701733319937	3810900	Rørholderflange, hvid, 20 mm	1	Stk.			
31.995	5701733319951	3810918	Rørholderflange, hvid, 25 mm	1	Stk.			

Nr.	EAN Nr.	TUN	Tekst	Indh.	Enh.	PG	Pris	Bestil.
-----	---------	-----	-------	-------	------	----	------	---------

**RØRHOLDERE,
MESSING**

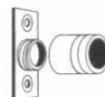

32.512	5701733325129	4188363	MINIPAK,rørholder,mess.lige, 1/2"	2	Pose	20		
32.519	5701733325198	4188371	MINIPAK,rørholder,mess.lige, 3/4"	2	Pose	22		
32.525	5701733325259	4188389	MINIPAK,rørholder,mess.lige, 1"	2	Pose	23		
31.512	5701733315120	3771185	Rørholder, messing, lige, 1/2"	20	Æske			
31.519	5701733315199	3771193	Rørholder, messing, lige, 3/4"	20	Æske			
31.525	5701733315250	3771201	Rørholder, messing, lige, 1"	20	Æske			

**RØRHOLDERE,
MESSING**



32.612	5701733326126	4188397	MINIPAK,rørholder,mess.vinkel,1/2"	2	Pose	20		
32.619	5701733326195	4188405	MINIPAK,rørholder,mess.vinkel,3/4"	2	Pose	22		
32.625	5701733326256	4188413	MINIPAK,rørholder,mess.vinkel, 1"	2	Pose	24		
31.612	5701733316127	3771219	Rørholder, messing, vinkel, 1/2"	20	Æske			
31.619	5701733316196	3771227	Rørholder, messing, vinkel, 3/4"	20	Æske			
31.625	5701733316257	3771235	Rørholder, messing, vinkel, 1"	20	Æske			

**RØRHOLDERE,
FORNIKLEDE**



31.652	5701733316523		Rørholder, forn., skjult skrue, 1/2"	20	Æske			
31.659	5701733316592		Rørholder, forn., skjult skrue, 3/4"	20	Æske			
31.665	5701733316653		Rørholder, forn., skjult skrue, 1"	20	Æske			

**RØRHOLDERE,
FORNIKLEDE**

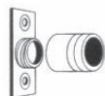

32.712	5701733327123	4188306	MINIPAK,rørholder,forn.lige, 1/2"	2	Pose	20		
32.719	5701733327192	4188314	MINIPAK,rørholder,forn.lige, 3/4"	2	Pose	22		
32.725	5701733327253	4188322	MINIPAK,rørholder,forn.lige, 1"	2	Pose	23		
31.712	5701733317124	3771243	Rørholder, fornicket, lige, 1/2"	20	Æske			
31.719	5701733317193	3771250	Rørholder, fornicket, lige, 3/4"	20	Æske			
31.725	5701733317254	3771268	Rørholder, fornicket, lige, 1"	20	Æske			

**RØRHOLDERE,
FORNIKLEDE**



32.812	5701733328120	4188330	MINIPAK,rørholder,forn.vinkel, 1/2"	2	Pose	20		
32.819	5701733328199	4188348	MINIPAK,rørholder,forn.vinkel, 3/4"	2	Pose	22		
32.825	5701733328250	4188355	MINIPAK,rørholder,forn.vinkel, 1"	2	Pose	24		
31.812	5701733318121	3771276	Rørholder, fornicket, vinkel, 1/2"	20	Æske			
31.819	5701733318190	3771284	Rørholder, fornicket, vinkel, 3/4"	20	Æske			
31.825	5701733318251	3771292	Rørholder, fornicket, vinkel, 1"	20	Æske			

**AFSTANDSHOLDERE,
LUKKEDE, HVIDE, 55MM**



31.900	5701733319005	3603024	MINIPAK,afstandsholder,lukket,3/4"	2	Pose	27		
31.901	5701733319012	3603032	MINIPAK,afstandsholder,lukket, 1"	2	Pose	28		
31.890	5701733318909	3771326	Afstandsholder,lukket, 3/4"	1	Stk.			
31.891	5701733318916	3771334	Afstandsholder,lukket, 1"	1	Stk.			

Nr.	EAN Nr.	TUN	Tekst	Indh.	Enh.	PG	Pris	Bestil.
-----	---------	-----	-------	-------	------	----	------	---------

**AFSTANDSHOLDERE,
ÅBNE, HVIDE, 55 MM**

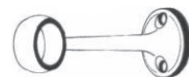

31.910	5701733319104	3603040	MINIPAK,afstandsholder,åben, 3/4"	2	Pose	30		
31.911	5701733319111	3603057	MINIPAK,afstandsholder,åben, 1"	2	Pose	30		
31.896	5701733318961	3771367	Afstandsholder,åben, 3/4"	1	Stk.			
31.897	5701733318978	3771375	Afstandsholder,åben, 1"	1	Stk.			

**MESSING PROFILER,
RUNDT RØR**



34.102	5701733341020	4883468	Messing rør, 4 x 0,5 mm, 1m	1	Stk.	B		
34.103	5701733341037	4883476	Messing rør, 6 x 0,5 mm, 1m	1	Stk.	D		
34.104	5701733341044	4883484	Messing rør, 8 x 0,5 mm, 1m	1	Stk.	E		

**MESSING PROFILER,
FLAD STANG**



34.110	5701733341105	4883526	Messing flad, 7 x 2,5 mm, 1m	1	Stk.	F		
34.112	5701733341129	4883518	Messing flad, 15 x 2,0 mm, 1m	1	Stk.	I		

**MESSING PROFILER,
VINKEL, LIGESIDET**



34.121	5701733341211	3658820	Messing vinkel, 8 x 8 x 0,8, 1 m	1	Stk.	K		
34.123	5701733341235	4883542	Messing vinkel, 15 x 15 x 1,5, 1 m	1	Stk.	L		
34.125	5701733341259	5680112	Messing vinkel, 25 x 25 x 2,0, 1 m	1	Stk.	P		
34.126	5701733341266	4883567	Messing vinkel, 30 x 30 x 2,0, 1 m	1	Stk.	Q		

**MESSING PROFILER,
VINKEL, ULIGESIDET**



34.127	5701733341273	4883575	Messing vinkel, 12 x 20 x 2,0, 1 m	1	Stk.	L		
34.128	5701733341280	4883583	Messing vinkel, 15 x 30 x 2,0, 1 m	1	Stk.	P		

**MESSING PROFILER,
U - PROFIL**



34.140	5701733341402	4883591	Messing U-profil, 6 x 6 x 0,8, 1 m	1	Stk.	K		
34.150	5701733341501	4883609	Messing U-profil, 6 x10 x 0,8, 1 m	1	Stk.	L		

**MESSING PROFILER,
RUND STANG**



34.165	5701733341655	4883641	Messing rund stang, 10 mm, 1 m	1	Stk.	O		
--------	---------------	---------	--------------------------------	---	------	---	--	--

Nr.	EAN Nr.	TUN	Tekst	Indh.	Enh.	PG	Pris	Bestil.
-----	---------	-----	-------	-------	------	----	------	---------

**PLAST PROFILER,
HVID, VINKEL, LIGESIDET**



34.215	5701733342157	4883666	Vinkel, hvid, 15x15 x 1,0 mm, 1 m	1	Stk.	A		
34.220	5701733342201	4883674	Vinkel, hvid, 20x20 x 1,0 mm, 1 m	1	Stk.	B		
34.225	5701733342256	4883682	Vinkel, hvid, 25x25 x 1,0 mm, 1 m	1	Stk.	B		
34.226	5701733342263	5680113	Vinkel, hvid, 30x30 x 1,2 mm, 1 m	1	Stk.	E		
35.710	5701733357106	4883732	Vinkel, hvid, 10x10 x 1,0 mm, 2 m	1	Stk.	D		
35.715	5701733357151	4883740	Vinkel, hvid, 15x15 x 1,0 mm, 2 m	1	Stk.	D		
35.720	5701733357205	4883757	Vinkel, hvid, 20x20 x 1,0 mm, 2 m	1	Stk.	E		
35.725	5701733357250	4883765	Vinkel, hvid, 25x25 x 1,0 mm, 2 m	1	Stk.	E		
35.726	5701733357267	5680119	Vinkel, hvid, 30x30 x 1,2 mm, 2 m	1	Stk.	J		

**PLAST PROFILER,
HVID, U - PROFIL**



34.228	5701733342287	5680114	U-profil, hvid, 10,5x11,5x1,0mm, 1 m	1	Stk.	A		
35.728	5701733357281	5680120	U-profil, hvid, 10,5x11,5x1,0mm, 2 m	1	Stk.	D		

**PLAST PROFILER,
HVID, VINKEL, ULIGESIDET**



34.245	4004338479275	4883724	Vinkel, hvid, 10x40 x 2,0 mm, 1 m	1	Stk.	D		
34.235	4004338479244	4883708	Vinkel, hvid, 20x25 x 2,0 mm, 1 m	1	Stk.	D		
34.240	4004338479268	4883716	Vinkel, hvid, 20x30 x 3,0 mm, 1 m	1	Stk.	E		
35.730	4004338479329	4883773	Vinkel, hvid, 10x20 x 1,5 mm, 2 m	1	Stk.	D		
35.745	4004338479374	4883807	Vinkel, hvid, 10x40 x 2,0 mm, 2 m	1	Stk.	G		
35.735	4004338479343	4883781	Vinkel, hvid, 20x25 x 2,0 mm, 2 m	1	Stk.	G		
35.740	4004338479367	4883799	Vinkel, hvid, 20x30 x 3,0 mm, 2 m	1	Stk.	I		

**ALU PROFILER,
RUNDT RØR**



35.301	5701733353016	4882791	Alu rør, 6 x 1,0 mm, 1 m	1	Stk.	B		
35.302	5701733353023	4882809	Alu rør, 8 x 1,0 mm, 1 m	1	Stk.	B		
35.303	5701733353030	4882817	Alu rør, 10 x 1,0 mm, 1 m	1	Stk.	D		
35.304	5701733353047	4882825	Alu rør, 12 x 1,0 mm, 1 m	1	Stk.	D		
35.305	5701733353054	4882833	Alu rør, 16 x 1,0 mm, 1 m	1	Stk.	E		
35.601	5701733356017	4883195	Alu rør, 6 x 1,0 mm, 2 m	1	Stk.	E		
35.602	5701733356024	4883203	Alu rør, 8 x 1,0 mm, 2 m	1	Stk.	E		
35.603	5701733356031	4883211	Alu rør, 10 x 1,0 mm, 2 m	1	Stk.	G		
35.604	5701733356048	4883229	Alu rør, 12 x 1,0 mm, 2 m	1	Stk.	G		
35.605	5701733356055	4883237	Alu rør, 16 x 1,0 mm, 2 m	1	Stk.	I		

**ALU PROFILER,
FLAD STANG**



35.312	5701733353122	4882841	Alu flad, 15 x 2,0 mm, 1 m	1	Stk.	D		
35.310	5701733353108	4882858	Alu flad, 20 x 2,0 mm, 1 m	1	Stk.	D		
35.313	5701733353139	4882866	Alu flad, 25 x 2,0 mm, 1 m	1	Stk.	E		
35.311	5701733353115	4882874	Alu flad, 30 x 2,0 mm, 1 m	1	Stk.	G		
35.612	5701733356123	4883245	Alu flad, 15 x 2,0 mm, 2 m	1	Stk.	G		
35.610	5701733356109	4883252	Alu flad, 20 x 2,0 mm, 2 m	1	Stk.	G		
35.613	5701733356130	4883260	Alu flad, 25 x 2,0 mm, 2 m	1	Stk.	K		
35.611	5701733356116	4883278	Alu flad, 30 x 2,0 mm, 2 m	1	Stk.	L		

Nr.	EAN Nr.	TUN	Tekst	Indh.	Enh.	PG	Pris	Bestil.
-----	---------	-----	-------	-------	------	----	------	---------

**ALU PROFILER,
VINKEL, LIGESIDET**



35.320	5701733353207	4882882	Alu vinkel, 10 x 10 x 1,0 mm, 1 m	1	Stk.	B		
35.321	5701733353214	4882890	Alu vinkel, 15 x 15 x 1,5 mm, 1 m	1	Stk.	D		
35.322	5701733353221	4882908	Alu vinkel, 20 x 20 x 1,5 mm, 1 m	1	Stk.	E		
35.323	5701733353238	4882916	Alu vinkel, 25 x 25 x 1,5 mm, 1 m	1	Stk.	G		
35.620	5701733356208	4883286	Alu vinkel, 10 x 10 x 1,0 mm, 2 m	1	Stk.	E		
35.621	5701733356215	4883294	Alu vinkel, 15 x 15 x 1,5 mm, 2 m	1	Stk.	G		
35.622	5701733356222	4883302	Alu vinkel, 20 x 20 x 1,5 mm, 2 m	1	Stk.	K		
35.623	5701733356239	4883310	Alu vinkel, 25 x 25 x 1,5 mm, 2 m	1	Stk.	L		

**ALU PROFILER,
VINKEL, ULIGESIDET**



35.330	5701733353306	4882924	Alu vinkel, 15 x 10 x 1,0 mm, 1 m	1	Stk.	D		
35.331	5701733353313	4882932	Alu vinkel, 20 x 10 x 2,0 mm, 1 m	1	Stk.	E		
35.332	5701733353320	4882940	Alu vinkel, 25 x 15 x 1,5 mm, 1 m	1	Stk.	G		
35.334	5701733353344	4882957	Alu vinkel, 30 x 20 x 1,5 mm, 1 m	1	Stk.	H		
35.333	5701733353337	4882965	Alu vinkel, 40 x 20 x 1,5 mm, 1 m	1	Stk.	I		
35.630	5701733356307	4883328	Alu vinkel, 15 x 10 x 1,0 mm, 2 m	1	Stk.	G		
35.631	5701733356314	4883336	Alu vinkel, 20 x 10 x 2,0 mm, 2 m	1	Stk.	I		
35.632	5701733356321	4883344	Alu vinkel, 25 x 15 x 1,5 mm, 2 m	1	Stk.	L		
35.634	5701733356345	4883351	Alu vinkel, 30 x 20 x 1,5 mm, 2 m	1	Stk.	O		
35.633	5701733356338	4896874	Alu vinkel, 40 x 20 x 1,5 mm, 2 m	1	Stk.	P		

**ALU PROFILER,
H - PROFIL**



35.339	5701733353399	4882981	Alu H-profil, 13x13,5x1,5 mm, 1 m	1	Stk.	H		
35.638	5701733356383	4883096	Alu H-profil, 8x11,5x1,5 mm, 2 m	1	Stk.	K		
35.639	5701733356390	4883104	Alu H-profil, 13x13,5x1,5 mm, 2 m	1	Stk.	N		

**ALU PROFILER,
U - PROFIL**



35.340	5701733353405	4882999	Alu U-profil, 10x10,0x 1,0 mm, 1 m	1	Stk.	D		
35.346	5701733353467	4883005	Alu U-profil, 8x13,5x 1,5 mm, 1 m	1	Stk.	E		
35.347	5701733353474	4883013	Alu U-profil, 10x16,5x 1,5 mm, 1 m	1	Stk.	F		
35.348	5701733353481	4883021	Alu U-profil, 10x19,5x 1,5 mm, 1 m	1	Stk.	F		
35.349	5701733353498	4883039	Alu U-profil, 10x22,5x 1,5 mm, 1 m	1	Stk.	G		
35.640	5701733356406	4883161	Alu U-profil, 10x10,0x 1,0 mm, 2 m	1	Stk.	G		
35.646	5701733356468	4883120	Alu U-profil, 8x13,5x 1,5 mm, 2 m	1	Stk.	I		
35.647	5701733356475	4883138	Alu U-profil, 10x16,5x 1,5 mm, 2 m	1	Stk.	K		
35.648	5701733356482	4883146	Alu U-profil, 10x19,5x 1,5 mm, 2 m	1	Stk.	K		
35.649	5701733356499	4883153	Alu U-profil, 10x22,5x 1,5 mm, 2 m	1	Stk.	L		

**ALU PROFILER,
FIRKANT RØR**



35.352	5701733353528	5680115	Alu firkt.rør, 15 x 15 x 1,5 mm, 1 m	1	Stk.	H		
35.353	5701733353535	5680116	Alu firkt.rør, 20 x 20 x 1,5 mm, 1 m	1	Stk.	I		
35.652	5701733356529	5680117	Alu firkt.rør, 15 x 15 x 1,5 mm, 2 m	1	Stk.	L		
35.653	5701733356536	5680118	Alu firkt.rør, 20 x 20 x 1,5 mm, 2 m	1	Stk.	M		

Nr.	EAN Nr.	TUN	Tekst	Indh.	Enh.	PG	Pris	Bestil.
-----	---------	-----	-------	-------	------	----	------	---------

**ALU PROFILER,
RUND STANG**



35.363	5701733353634	5029989	Alu rund stang, 4 mm, 1 m	1	Stk.	B		
35.360	5701733353603	4882767	Alu rund stang, 8 mm, 1 m	1	Stk.	E		
35.361	5701733353610	4882775	Alu rund stang, 10 mm, 1 m	1	Stk.	G		
35.362	5701733353627	4882783	Alu rund stang, 12 mm, 1 m	1	Stk.	H		
35.660	5701733356604	4883112	Alu rund stang, 8 mm, 2 m	1	Stk.	I		
35.661	5701733356611	4883179	Alu rund stang, 10 mm, 2 m	1	Stk.	L		
35.662	5701733356628	4883187	Alu rund stang, 12 mm, 2 m	1	Stk.	N		

**ALU PROFILER,
FIRKANT STANG**



35.372	5701733353726	4882726	Alu firk.stang, 12 x 12 mm, 1 m	1	Stk.	J		
35.374	4004338473235	4882734	Alu firk.stang, 16 x 16 mm, 1 m	1	Stk.	O		
35.670	4004338474218	4883047	Alu firk.stang, 10 x 10 mm, 2 m	1	Stk.	N		
35.674	4004338474232	4883062	Alu firk.stang, 16 x 16 mm, 2 m	1	Stk.	T		

**ALU PROFILER,
T - PROFIL**



35.380	5701733353801	4882742	Alu T-profil, 15 x 15 x 2,0 mm, 1 m	1	Stk.	F		
35.382	5701733353825	4882759	Alu T-profil, 20 x 20 x 2,0 mm, 1 m	1	Stk.	G		
35.680	5701733356802	4883070	Alu T-profil, 15 x 15 x 2,0 mm, 2 m	1	Stk.	K		
35.682	5701733356826	4883088	Alu T-profil, 20 x 20 x 2,0 mm, 2 m	1	Stk.	L		

Nr.	EAN Nr.	TUN	Tekst	Indh.	Enh.	PG	Pris	Bestil.
-----	---------	-----	-------	-------	------	----	------	---------

**TÆPPESKINNER,
BUEDE, MED SKRUEHULLER**



36.001	5701733360014	3663226	Tæppesk.mess.o.t., 30 mm, 0,9 m	1	Stk.	G		
36.021	5701733360212	5137600	Tæppesk.rustfr.stål, 30 mm, 0,9 m	1	Stk.	I		
36.022	4012406000252	5324848	Tæppesk.RS sidehul, 30mm, 0,9 m	1	Stk.	nil		
36.051	5701733360519	7752173	Tæppeskinne, alum, 30 mm, 0,9 m	1	Stk.	G		
36.091	5701733360915	5137602	Tæppeskinne, sølv, 30 mm, 0,9 m	1	Stk.	H		
36.081	5701733360816	5137604	Tæppeskinne, guld, 30 mm, 0,9 m	1	Stk.	H		
36.011	5701733360113	3663234	Tæppesk.mess.o.t., 40 mm, 0,9 m	1	Stk.	I		
36.033	5701733360335	5137613	Tæppesk.rustfr.stål, 40 mm, 0,9 m	1	Stk.	K		
36.041	4012406000214	5324849	Tæppesk.RS sidehul 40mm, 0,9 m	1	Stk.	nil		
36.034	5701733360342	5137615	Tæppeskinne, sølv, 40 mm, 0,9 m	1	Stk.	L		
36.035	5701733360359	5137618	Tæppeskinne, guld, 40 mm, 0,9 m	1	Stk.	L		
36.037	5701733360373	5137621	Tæppeskinne, sølv, 50 mm, 0,9 m	1	Stk.	N		
36.038	5701733360380	5137623	Tæppeskinne, guld, 50 mm, 0,9 m	1	Stk.	N		
36.039	5701733360397	1319161	Tæppesk.sølv,60mm,0,9m		Stk.	O		
36.040	5701733360403	1319162	Tæppesk.guld,60mm,0,9m		Stk.	O		
36.502	5701733365026	5764030	Tæppesk.mess.o.t., 30 mm, 1,8 m	1	Stk.	L		
36.522	5701733365224	5137601	Tæppesk.rustfr.stål, 30 mm, 1,8 m	1	Stk.	O		
36.552	5701733365521	5764055	Tæppeskinne, alum, 30 mm, 1,8 m	1	Stk.	L		
36.592	5701733365927	5137603	Tæppeskinne, sølv, 30 mm, 1,8 m	1	Stk.	N		
36.582	5701733365828	5137605	Tæppeskinne, guld, 30 mm, 1,8 m	1	Stk.	N		
36.512	5701733365125	5764048	Tæppesk.mess.o.t., 40mm, 1,8 m	1	Stk.	O		
36.533	5701733365330	5137614	Tæppesk.rustfr.stål, 40mm, 1,8 m	1	Stk.	P		
36.534	5701733365347	5137616	Tæppeskinne, sølv, 40 mm, 1,8 m	1	Stk.	P		
36.535	5701733365354	5137619	Tæppeskinne, guld, 40 mm, 1,8 m	1	Stk.	P		
36.537	5701733365378	5137622	Tæppeskinne, sølv, 50 mm, 1,8 m	1	Stk.	Q		
36.538	5701733365385	5137624	Tæppeskinne, guld, 50 mm, 1,8 m	1	Stk.	Q		
36.539	5701733365392	1319163	Tæppesk.sølv,60mm,1,8m		Stk.	T		
36.540	5701733365408	1319164	Tæppesk.guld,60mm,1,8m		Stk.	T		
37.005	5701733370051	3663309	Tæppesk.mess.o.t., 30mm, 2,7 m	1	Stk.	N		
37.007	4012406000245	5324850	Tæppesk.RS sidehul 30mm, 2,7 m	1	Stk.	nil		
37.015	5701733370150	3663317	Tæppesk.mess.o.t., 40mm, 2,7 m	1	Stk.	Q		
37.017	4012406000207	5324851	Tæppesk.RS sidehul 40mm, 2,7 m	1	Stk.	nil		
37.039	5701733370396	5324867	Tæppesk.sølv,60mm,2,7m		STK.	U		
37.040	5701733370402	5324868	Tæppesk.guld,60mm,2,7m		STK.	U		

**TÆPPESKINNER,
BUEDE, SELVKLÆBENDE**



36.061	5701733360618	5956582	Tæppesk.guld,selvkl.30 mm, 0,9 m	1	Stk.	I		
36.071	5701733360717	5956583	Tæppesk.sølv,selvkl.30 mm, 0,9 m	1	Stk.	I		
36.036	5701733360366	5137620	Tæppesk.sølv,selvkl.40 mm, 0,9 m	1	Stk.	N		
36.562	5701733365620	5956584	Tæppesk.guld,selvkl.30 mm, 1,8 m	1	Stk.	N		
36.572	5701733365729	5956585	Tæppesk.sølv,selvkl.30 mm, 1,8 m	1	Stk.	N		
37.065	5701733370655	5956586	Tæppesk.guld,selvkl.30 mm, 2,7 m	1	Stk.	Q		
37.075	5701733370754	5956587	Tæppesk.sølv,selvkl.30 mm, 2,7 m	1	Stk.	Q		

Nr.	EAN Nr.	TUN	Tekst	Indh.	Enh.	PG	Pris	Bestil.
-----	---------	-----	-------	-------	------	----	------	---------

AFSLUTNINGSSKINNER, MED SKRUEHULLER



36.201	5701733362018	3663267	Afslutn.skinne, guld, 25 mm, 0,9 m	1	Stk.	H		
36.211	5701733362117	3663275	Afslutn.skinne, sølv, 25 mm, 0,9 m	1	Stk.	H		
36.261	5701733362612	5956594	Afslutn.skinne, guld, 38 mm, 0,9 m	1	Stk.	I		
36.271	5701733362711	5956595	Afslutn.skinne, sølv, 38 mm, 0,9 m	1	Stk.	I		
36.702	5701733367020	5764089	Afslutn.skinne, guld, 25 mm, 1,8 m	1	Stk.	N		
36.712	5701733367129	5764097	Afslutn.skinne, sølv, 25 mm, 1,8 m	1	Stk.	N		
36.762	5701733367624	5956596	Afslutn.skinne, guld, 38 mm, 1,8 m	1	Stk.	O		
36.772	5701733367723	5956597	Afslutn.skinne, sølv, 38 mm, 1,8 m	1	Stk.	O		
37.205	5701733372055	3663341	Afslutn.skinne, guld, 25 mm, 2,7 m	1	Stk.	Q		
37.215	5701733372154	3663358	Afslutn.skinne, sølv, 25 mm, 2,7 m	1	Stk.	Q		
37.265	5701733372659	5956598	Afslutn.skinne, guld, 38 mm, 2,7 m	1	Stk.	Q		
37.275	5701733372758	5956599	Afslutn.skinne, sølv, 38 mm, 2,7 m	1	Stk.	U		

AFSLUTNINGSSKINNER, SELVKLÆBENDE

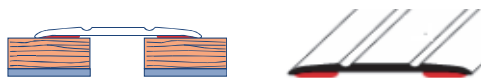

36.250	5701733362506	5137598	Afsl.skin.selvk. sølv, 30 mm, 0,9 m	1	Stk.	I		
37.255	5701733372550	5137599	Afsl.skin.selvk. sølv, 30 mm, 2,7 m	1	Stk.	R		
36.030	5701733360304	5137606	Afsl.skin.selvk. bøg, 38 mm, 0,9 m	1	Stk.	O		
36.031	5701733360311	5137608	Afsl.skin.selvk. eg, 38 mm, 0,9 m	1	Stk.	O		
36.032	5701733360328	5137611	Afsl.skin.selvk. ahorn, 38mm, 0,9 m	1	Stk.	O		
36.530	5701733365309	5137607	Afsl.skin.selvk. bøg, 38 mm, 1,8 m	1	Stk.	R		
36.531	5701733365316	5137610	Afsl.skin.selvk. eg, 38 mm, 1,8 m	1	Stk.	R		
36.532	5701733365323	5137612	Afsl.skin.selvk. ahorn, 38mm, 1,8 m	1	Stk.	R		

AFSLUTNINGSSKINNER, MED SKRUEHULLER, 4-5MM HØJDEUDLIGNING



36.101	5701733361011	3663242	Afslutn.skinne, guld, 30 mm, 0,9 m	1	Stk.	I		
36.111	5701733361110	3663259	Afslutn.skinne, sølv, 30 mm, 0,9 m	1	Stk.	I		
36.602	5701733366023	5764063	Afslutn.skinne, guld, 30 mm, 1,8 m	1	Stk.	O		
36.612	5701733366122	5764071	Afslutn.skinne, sølv, 30 mm, 1,8 m	1	Stk.	O		
37.105	5701733371058	3663325	Afslutn.skinne, guld, 30mm, 2,7 m	1	Stk.	Q		
37.115	5701733371157	3663333	Afslutn.skinne, sølv, 30mm, 2,7 m	1	Stk.	Q		

AFSLUTNINGSSKINNER, MED SKRUEHULLER, 8 MM HØJDEUDLIGNING

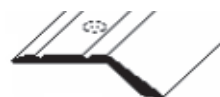

36.161	5701733361615	5956588	Afslutn.skinne, guld, 32 mm, 0,9 m	1	Stk.	I		
36.171	5701733361714	5956589	Afslutn.skinne, sølv, 32 mm, 0,9 m	1	Stk.	I		
36.662	5701733366627	5956590	Afslutn.skinne, guld, 32 mm, 1,8 m	1	Stk.	O		
36.672	5701733366726	5956591	Afslutn.skinne, sølv, 32 mm, 1,8 m	1	Stk.	O		
37.165	5701733371652	5956592	Afslutn.skinne, guld, 32 mm, 2,7 m	1	Stk.	Q		
37.175	5701733371751	5956593	Afslutn.skinne, sølv, 32 mm, 2,7 m	1	Stk.	Q		

NIVEAUSKINNE, MED SKRUEHULLER, 14 MM HØJDEUDLIGNING



36.181	5701733361813	5162207	Niveauskinne, guld, 44 mm, 0,9 m	1	Stk.	L		
36.191	5701733361912	5162209	Niveauskinne, sølv, 44 mm, 0,9 m	1	Stk.	L		
36.682	5701733366825	5162208	Niveauskinne, guld, 44 mm, 1,8 m.	1	Stk.	P		
36.691	5701733366917	5162210	Niveauskinne, sølv, 44 mm, 1,8 m.	1	Stk.	P		

Nr.	EAN Nr.	TUN	Tekst	Indh.	Enh.	PG	Pris	Bestil.
-----	---------	-----	-------	-------	------	----	------	---------

**VINKELSKINNE,
MED SKRUEHULLER**



36.321	5701733363213	5137586	Vinkelsk. guld, 25x10 mm, 0,9 m	1	Stk.	I		
36.331	5701733363312	5137584	Vinkelsk. sølv, 25x10 mm, 0,9 m	1	Stk.	I		
36.821	5701733368218	5137587	Vinkelsk. guld, 25x10 mm, 1,8 m	1	Stk.	O		
36.831	5701733368317	5137585	Vinkelsk. sølv, 25x10 mm, 1,8 m	1	Stk.	O		

**VINKELSKINNE,
SELVKLÆBENDE**



36.341	5701733363411	5137582	Vinkelsk.selvk.sølv,25x10mm,0,9m	1	Stk.	I		
--------	---------------	---------	----------------------------------	---	------	---	--	--

**VINKELSKINNE,
MED SKRUEHULLER**

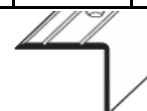

36.301	5701733363015	3663283	Vinkelsk. guld, 25x20 mm, 0,9 m	1	Stk.	I		
36.311	5701733363114	3663291	Vinkelsk. sølv, 25x20 mm, 0,9 m	1	Stk.	I		
36.802	5701733368027	5764105	Vinkelsk. guld, 25x20 mm, 1,8 m	1	Stk.	O		
36.812	5701733368126	5764113	Vinkelsk. sølv, 25x20 mm, 1,8 m	1	Stk.	O		
37.305	5701733373052	3663366	Vinkelsk. guld, 25x20 mm, 2,7 m	1	Stk.	Q		
37.315	5701733373151	3663374	Vinkelsk. sølv, 25x20 mm, 2,7 m	1	Stk.	Q		

**VINKELSKINNNE,
MED SKRUEHULLER**

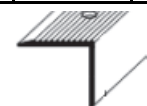

36.381	5701733363817	5137596	Vinkelsk. guld, 21x21 mm, 0,9 m	1	Stk.	K		
36.391	5701733363916	5137594	Vinkelsk. sølv, 21x21 mm, 0,9 m	1	Stk.	K		
36.881	5701733368812	5137597	Vinkelsk. guld, 21x21 mm, 1,8 m	1	Stk.	P		
36.891	5701733368911	5137595	Vinkelsk. sølv, 21x21 mm, 1,8 m	1	Stk.	P		
37.399	5701733373991	5137593	Vinkelsk. mess. 21x21 mm, 2,5m	1	Stk.	U		

**AFSLUTNINGSSKINNE,
MED SKRUEHULLER**

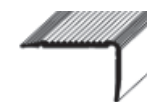

36.451	5701733364517	5162203	Afslutn.sk. guld, 30x20 mm, 0,9 m	1	Stk.	K		
36.452	5701733364524	5162204	Afslutn.sk. guld, 30x20 mm, 1,8 m	1	Stk.	P		

**VINKELSKINNE,
MED SKRUEHULLER**

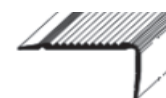

36.361	5701733363619	5956600	Vinkelsk. guld, 45x23 mm, 0,9 m	1	Stk.	N		
36.371	5701733363718	5956601	Vinkelsk. sølv, 45x23 mm, 0,9 m	1	Stk.	N		
36.862	5701733368621	5956602	Vinkelsk. guld, 45x23 mm, 1,8 m	1	Stk.	R		
36.872	5701733368720	5956603	Vinkelsk. sølv, 45x23 mm, 1,8 m	1	Stk.	R		
37.365	5701733373656	5956604	Vinkelsk. guld, 45x23 mm, 2,7 m	1	Stk.	U		
37.375	5701733373755	5956605	Vinkelsk. sølv, 45x23 mm, 2,7 m	1	Stk.	U		

**AFSLUTNINGSSKINNE,
MED SKRUEHULLER**



36.281	5701733362810	5137590	Afslutn.sk. guld, 23x6 mm, 0,9 m	1	Stk.	H		
36.291	5701733362919	5137588	Afslutn.sk. sølv, 23x6 mm, 0,9 m	1	Stk.	H		
36.781	5701733367815	5137592	Afslutn.sk. guld, 23x6 mm, 1,8 m	1	Stk.	O		
36.791	5701733367914	5137589	Afslutn.sk. sølv, 23x6 mm, 1,8 m	1	Stk.	O		

**AFSLUTNINGSSKINNE,
FOR BELÆGNINGSTYKKELSE 7-9 MM**



36.400	5701733364005	5162205	Afslutn.sk.guld 15, 7-9 mm, 0,9 m	1	Stk.	K		
36.402	5701733364029	5162206	Afslutn.sk.guld 15, 7-9 mm, 2,7 m	1	Stk.	P		

Nr.	EAN Nr.	TUN	Tekst	Indh.	Enh.	PG	Pris	Bestil.
-----	---------	-----	-------	-------	------	----	------	---------

**PROFI
TEC
MASTER**

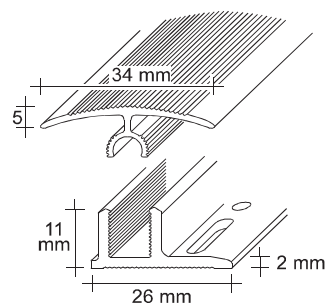
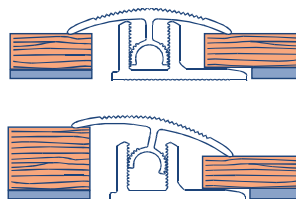

**OVERGANGSSKINNE MED BASISKINNE,
FOR BELÆGNINGSTYKKELSE 7-15 MM**

37.501	5701733375018	5137626	Overgang, sølv 34, 7-15mm, 0,9 m	1	Stk.	S		
37.502	5701733375025	5324869	Overg.sølv34, 7-15, 1,8m	1	STK.	U		
37.507	5701733375070	5137627	Overgang, sølv 34, 7-15mm, 2,7 m	1	Stk.	Y		
37.511	5701733375117	5162211	Overgang, guld 34, 7-15mm, 0,9 m	1	Stk.	S		
37.517	5701733375179	5162212	Overgang, guld 34, 7-15mm, 2,7 m	1	Stk.	Y		

**PROFI
TEC
XXL**

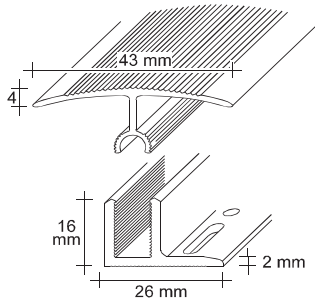
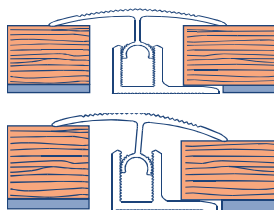

**OVERGANGSSKINNE MED BASISKINNE,
FOR BELÆGNINGSTYKKELSE 16-23,5 MM**

37.520	5701733375209	5137628	Overgang,sølv 43,16-23,5mm,0,9 m	1	Stk.	R		
37.522	5701733375223	5324870	Overg.sølv43,16-23,5, 1,8m	1	STK.	U		
37.527	5701733375278	5137629	Overgang,sølv 43,16-23,5mm,2,7 m	1	Stk.	Y		
37.530	5701733375308	5137630	Overgang,guld 43,16-23,5mm,0,9 m	1	Stk.	R		
37.537	5701733375377	5137631	Overgang,guld 43,16-23,5mm,2,7 m	1	Stk.	Y		

**PROFI
TEC
MASTER**

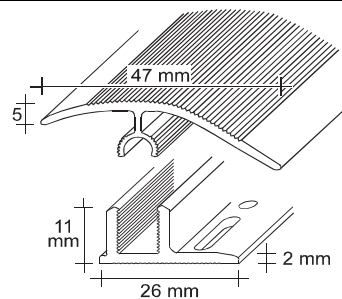
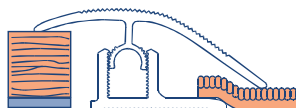

**NIVEAUSKINNE MED BASISKINNE,
FOR BELÆGNINGSTYKKELSE 7-17,5 MM**

37.541	5701733375414	5137632	Niveau, sølv 47, 7-17,5 mm, 0,9 m	1	Stk.	S		
37.542	5701733375421	5324871	Niveau.sølv 47, 7-17, 1,8m	1	STK.	U		
37.547	5701733375476	5137634	Niveau, sølv 47, 7-17,5 mm, 2,7 m	1	Stk.	Y		
37.551	5701733375513	5162213	Niveau, guld 47, 7-17,5 mm, 0,9 m	1	Stk.	S		
37.557	5701733375575	5162214	Niveau, guld 47, 7-17,5 mm, 2,7 m	1	Stk.	Y		

**PROFI
TEC
XXL**

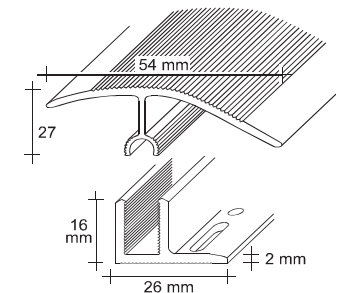
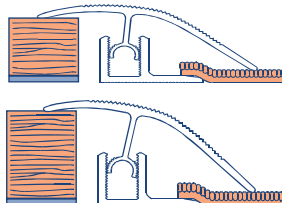

**NIVEAUSKINNE MED BASISKINNE,
FOR BELÆGNINGSTYKKELSE 16-23,5 MM**

37.560	5701733375605	5137635	Niveau, sølv 54, 16-23,5mm, 0,9 m	1	Stk.	T		
37.562	5701733375629	5324872	Niveau.sølv54,16-23,5, 1,8m	1	STK.	U		
37.567	5701733375674	5162199	Niveau, sølv 54, 16-23,5mm, 2,7 m	1	Stk.	Z		
37.570	5701733375704	5162200	Niveau, guld 54, 16-23,5mm, 0,9 m	1	Stk.	T		
37.577	5701733375773	5162202	Niveau, guld 54, 16-23,5mm, 2,7 m	1	Stk.	Z		

Nr.	EAN Nr.	TUN	Tekst	Indh.	Enh.	PG	Pris	Bestil.
-----	---------	-----	-------	-------	------	----	------	---------

**KLAVERHÆNGSEL,
MESSING, SB PAKKET MED SKRUER**

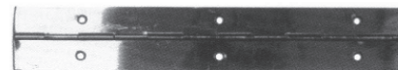

37.709	5701733377098	4126686	Klaverhængsel, 32, MS 900 mm		Stk.			
--------	---------------	---------	------------------------------	--	------	--	--	--

**KLAVERHÆNGSEL,
FORMESSINGET, SB PAKKET MED SKRUER**

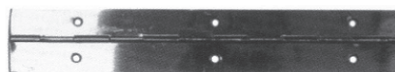

37.809	5701733378095	4126694	Klaverhængsel, 25, FM 900 mm		Stk.			
37.904	5701733379047	3770732	Klaverhængsel, 32, FM 400 mm		Stk.			
37.906	5701733379061	3770740	Klaverhængsel, 32, FM 600 mm		Stk.			
37.909	5701733379092	3770757	Klaverhængsel, 32, FM 900 mm		Stk.			
37.912	5701733379122	3770765	Klaverhængsel, 32, FM1200 mm		Stk.			

**KLAVERHÆNGSEL,
FORMESSINGET**

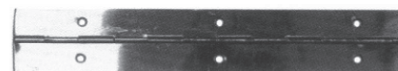

37.935	5701733379351	3770773	Klaverhængsel, 32, FM 3,5 m		Stk.			
--------	---------------	---------	-----------------------------	--	------	--	--	--

Oversigt prisgrupper:

PG	
A	
B	
D	
E	
F	
G	
H	
I	
J	
K	
L	
M	
N	
O	
P	
Q	
R	
S	
T	
U	
Y	
Z	